

8 7 6 5 4 3 2 1

D

D

C

C





B

B

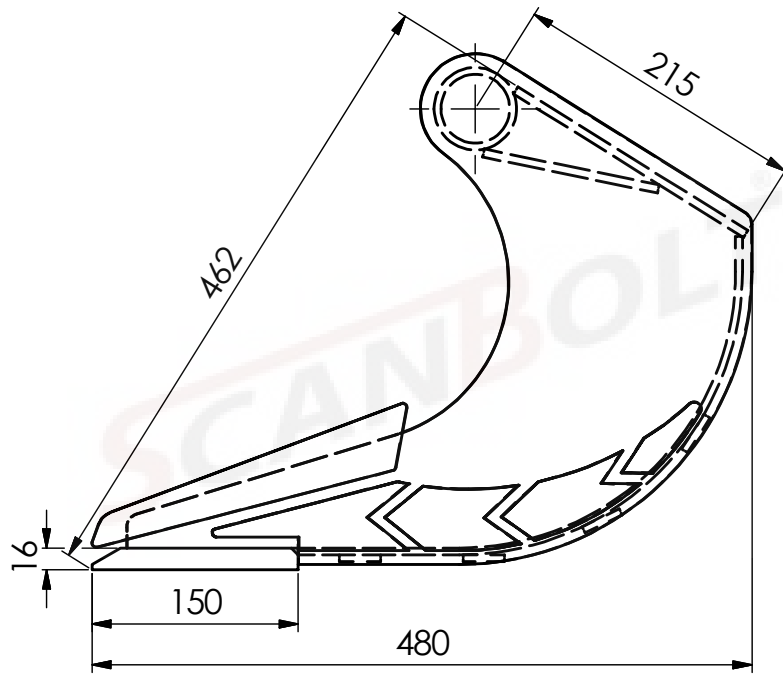
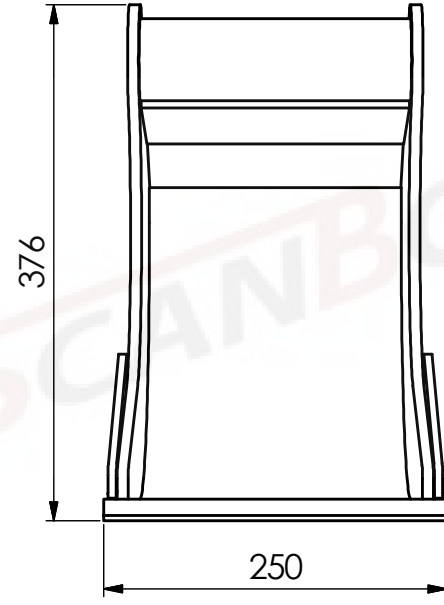
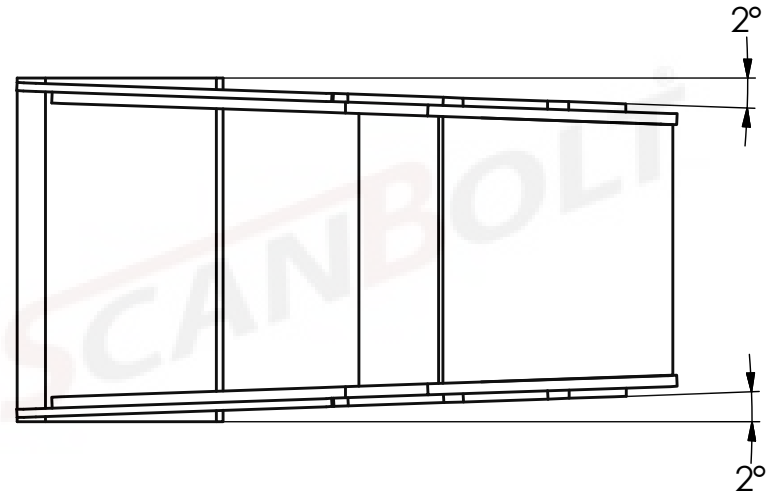
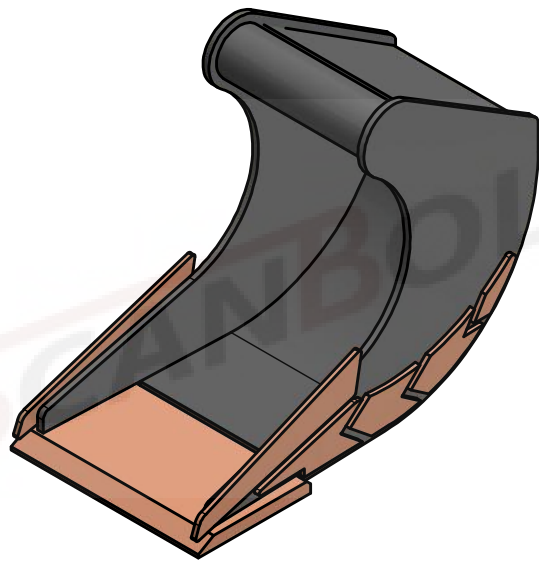
A

A



MATERIAL SPECIFICATION	
	ST52.3
	EN8D
	HB 400
	HB 450
	CASTALLOY STEEL

SCANBOLT®	
DESCRIPTION	25CM CLAY BUCKET
MACHINE CLASS	1.3-2.4 TON
WEIGHT	24.6 Kg
HEAPED CAPACITY	21.4 LITERS

8 7 6 5 4 3 2 1